

**GAGE-LINE<sup>®</sup> INSPECTION & CALIBRATION STANDARD NO. 2**

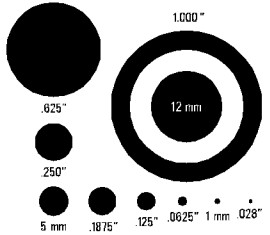

GAGE-LINE TECHNOLOGY, INC. ROCHESTER, NY PH. 585-458-2000

CAT. NO. 100733 COPYRIGHT © 2011 GLT

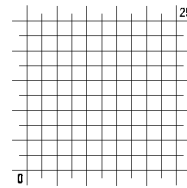
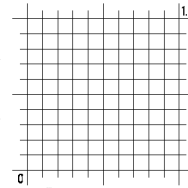
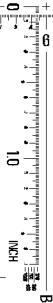
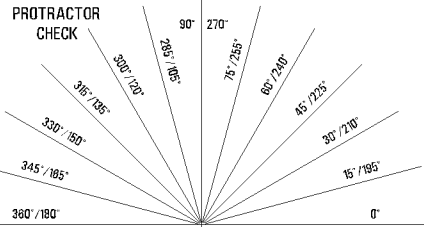
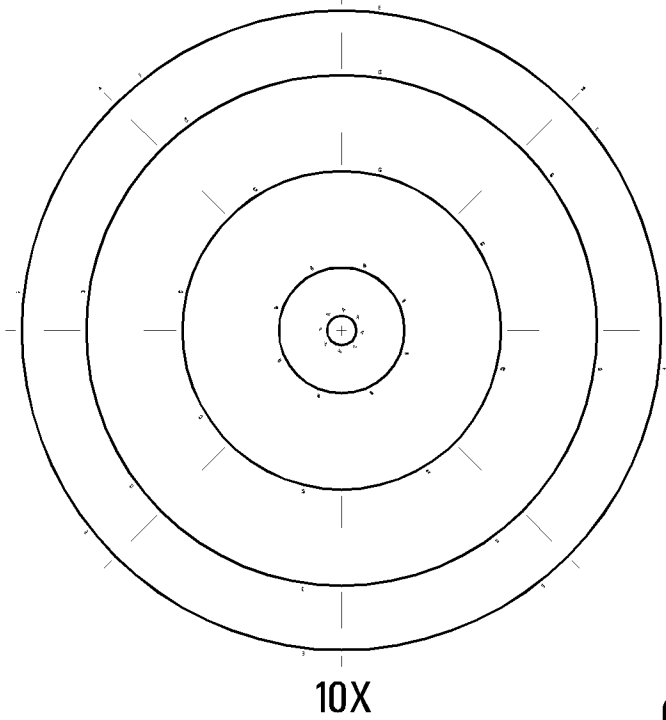
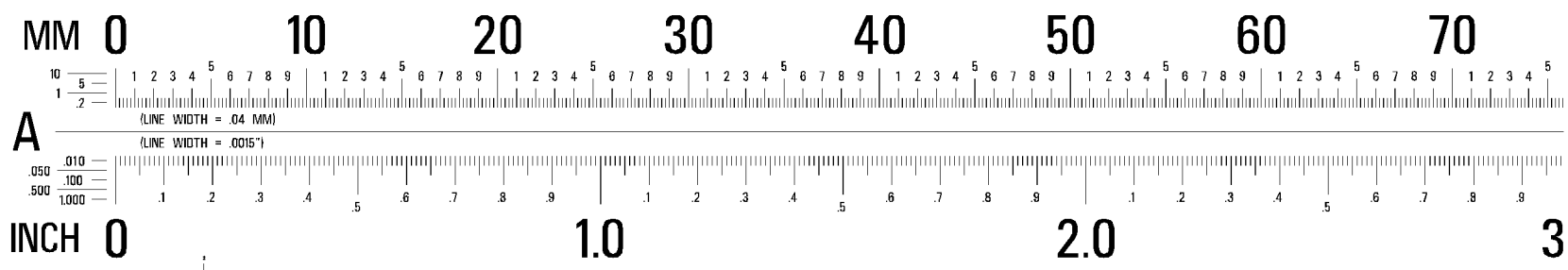

**MAGNIFICATION CHECK**  
 SET TO OUTSIDE EDGES OF LINES

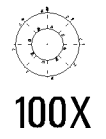
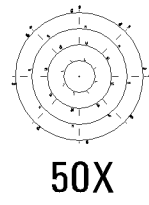
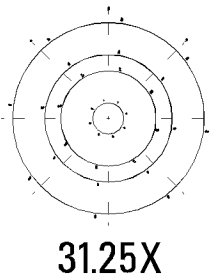
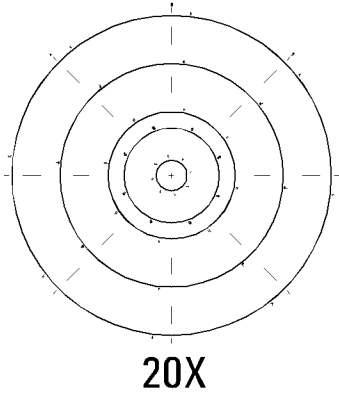

**GAGE-LINE<sup>®</sup> INSPECTION &  
 CALIBRATION STANDARD NO. 2**



**GAGE-LINE TECHNOLOGY, INC. ROCHESTER, NY PH. 585-458-2000**

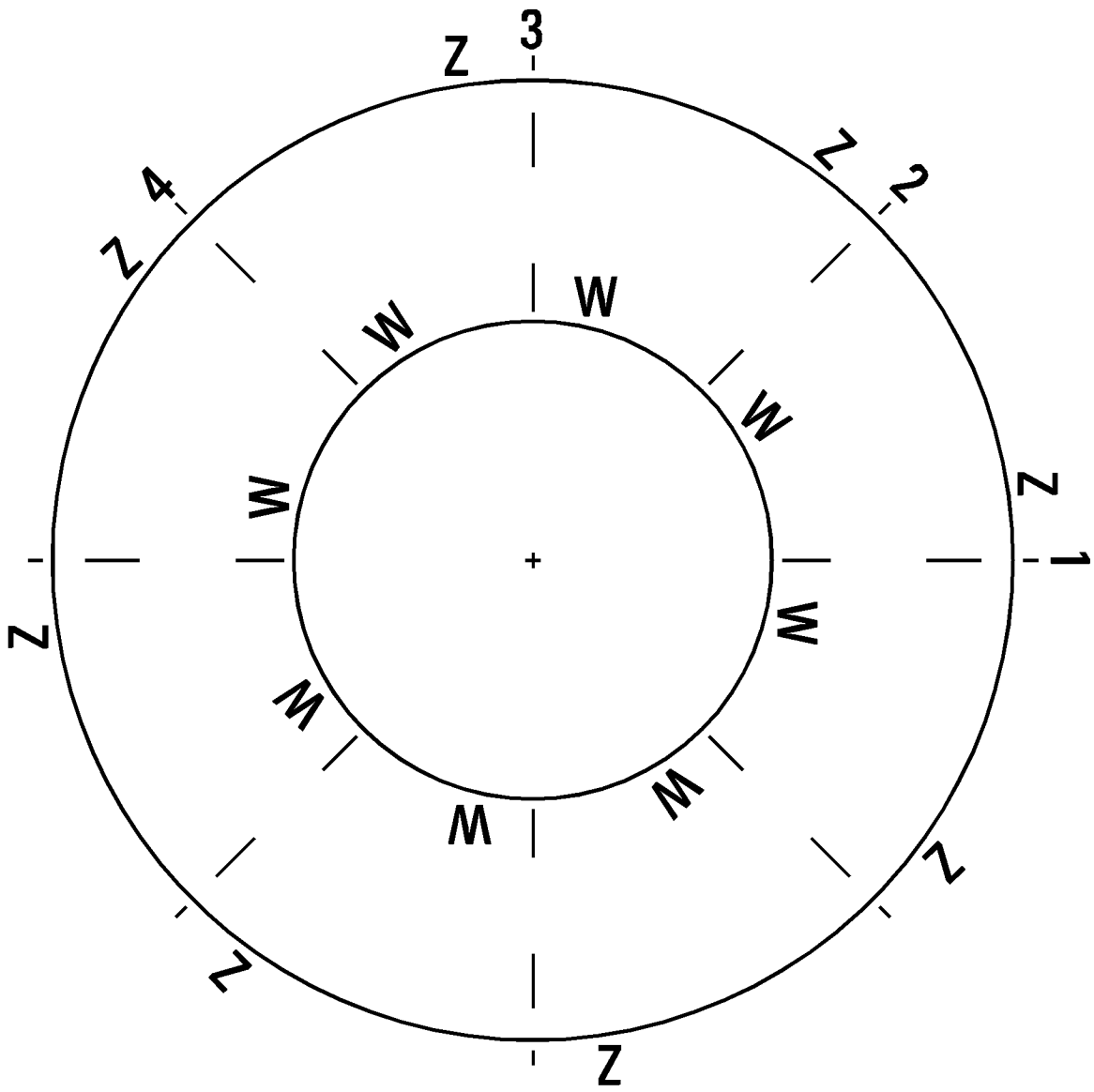

**1000X**

**MM 0**

**10**

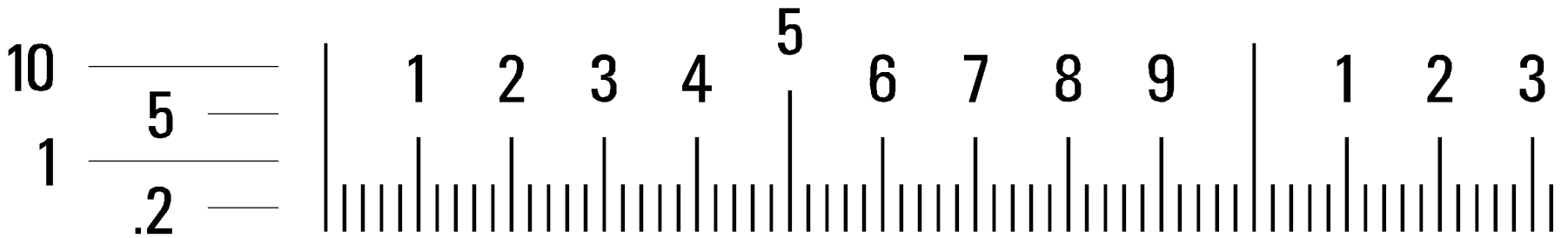

(LINE WIDTH = .04 MM)

**A**

(LINE WIDTH = .0015")

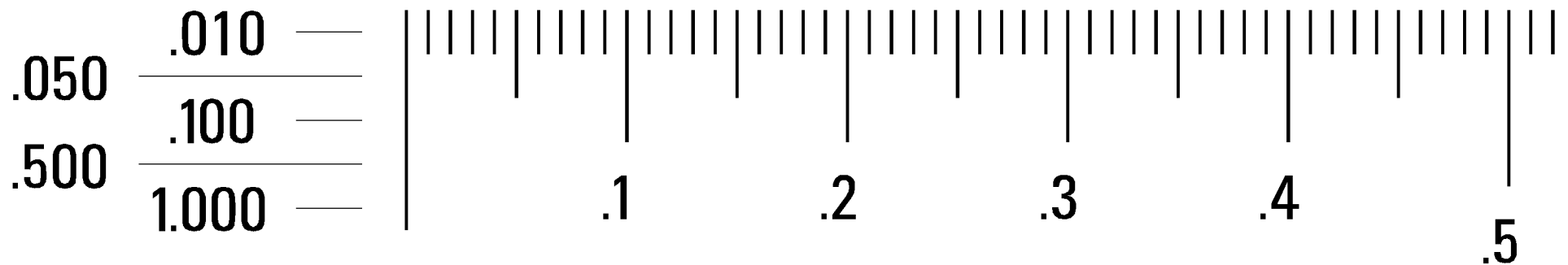

**INCH 0**

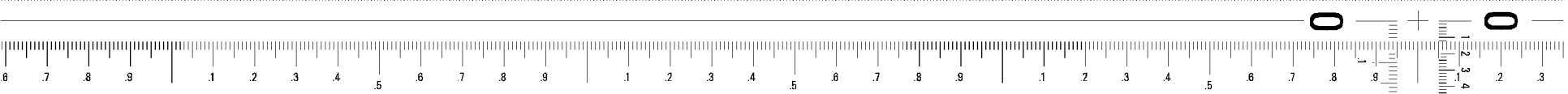

3.0 4.0 5.0

CK  
LINES

### PROTRACTOR CHECK

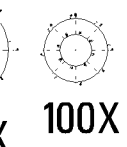

100X

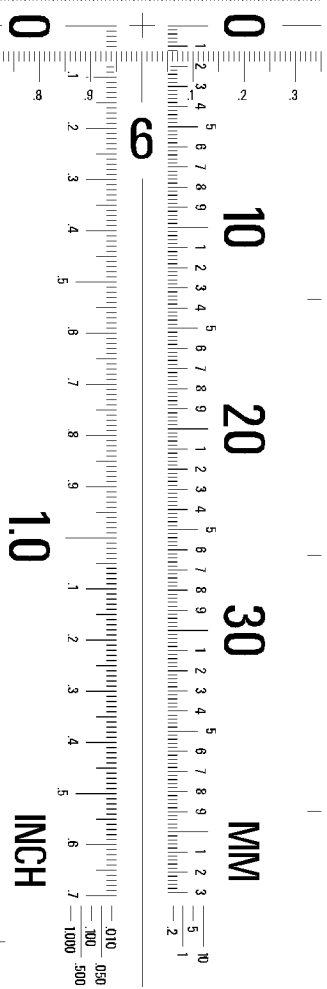
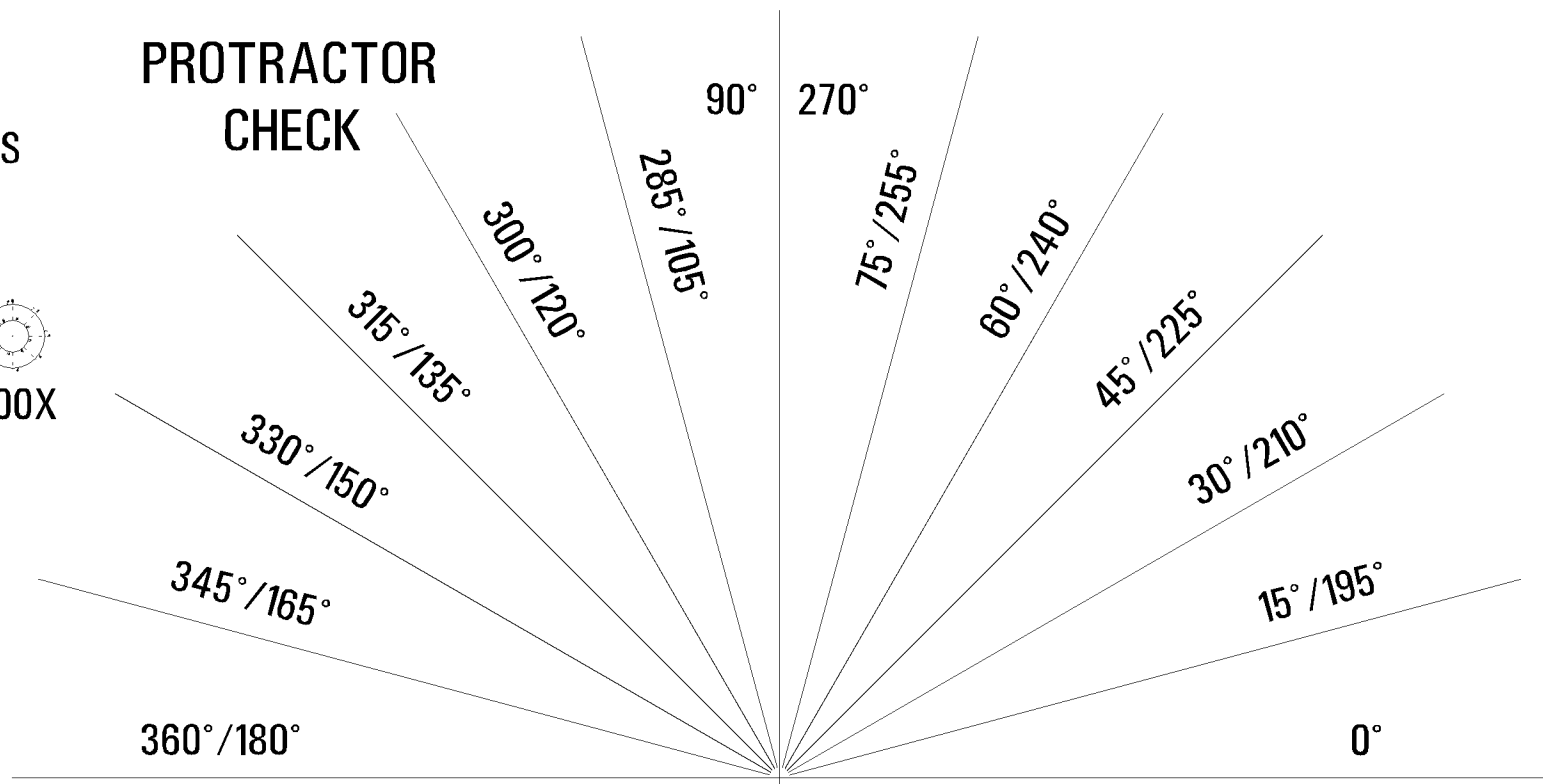

B

000

150 160 170 180 190 200 210 220 230

0 1 2 3 4 5 6 7 8 9 10 11 12 13 14 15 16 17 18 19 20 21 22 23 24 25 26 27 28 29 30 31 32 33 34 35 36 37 38 39 40 41 42 43 44 45 46 47 48 49 50 51 52 53 54 55 56 57 58 59 60 61 62 63 64 65 66 67 68 69 70 71 72 73 74 75 76 77 78 79 80 81 82 83 84 85 86 87 88 89 90 91 92 93 94 95 96 97 98 99 100

6 7.0 8.0 9.0

0 1 2 3 4 5 6 7 8 9 10 11 12 13 14 15 16 17 18 19 20 21 22 23 24 25 26 27 28 29 30 31 32 33 34 35 36 37 38 39 40 41 42 43 44 45 46 47 48 49 50 51 52 53 54 55 56 57 58 59 60 61 62 63 64 65 66 67 68 69 70 71 72 73 74 75 76 77 78 79 80 81 82 83 84 85 86 87 88 89 90 91 92 93 94 95 96 97 98 99 100

1.0

INCH

B

0 10 20 30 40 50 60 70 80 90 100

MM

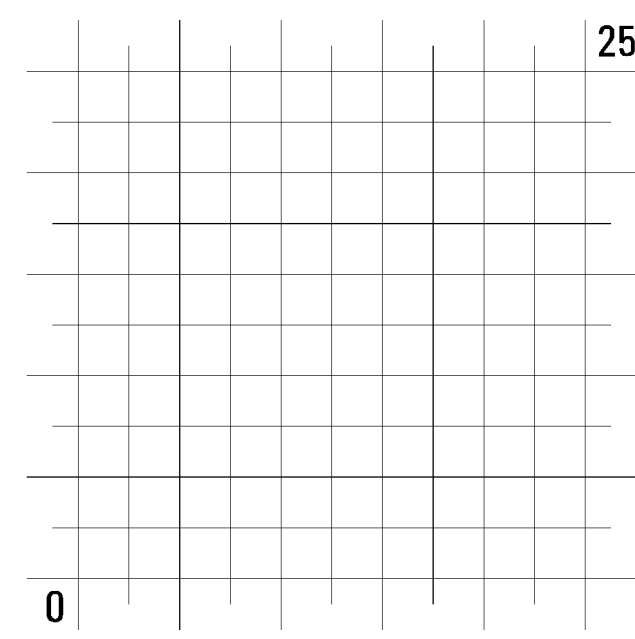
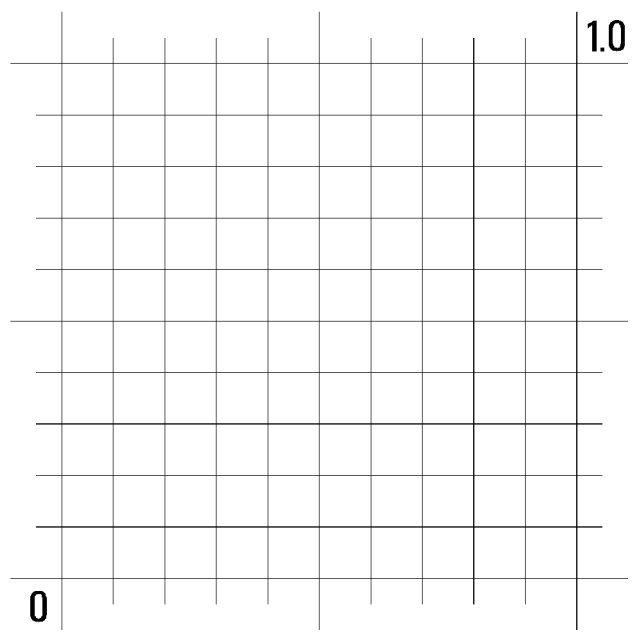

0.01



CAT. NO. 100733 COPYRIGHT © 2011 GLT



A

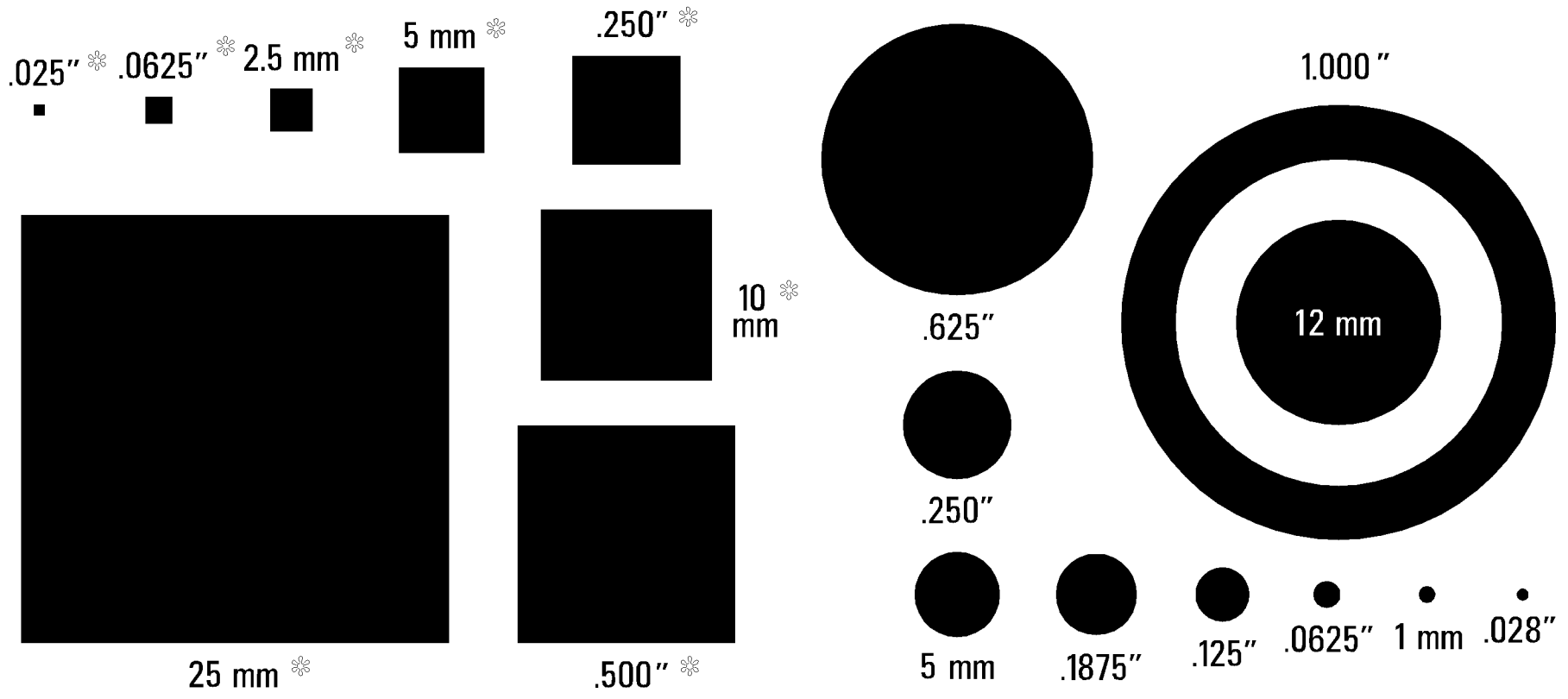
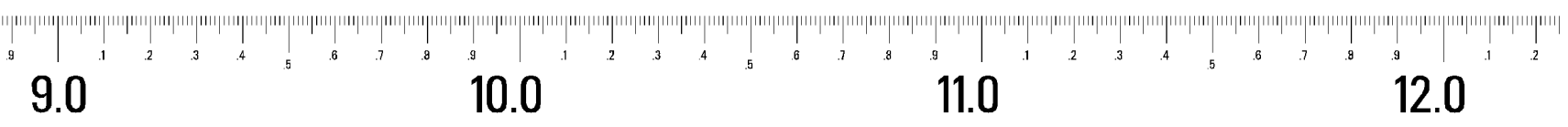

\*Text shown for reference. Text does not appear on standard.